



MULTILAYER CERAMIC CHIP CAPACITORS



CKG Series Mega Cap Type Capacitors

Type: CKG32K
CKG45K
CKG57K
CKG45N
CKG57N

Issue date: April 2011



**TDK MLCC
US Catalog**

Version B11

REMINDERS

Please read before using this product

SAFETY REMINDERS



REMINDERS

1. If you intend to use a product listed in this catalog for a purpose that may cause loss of life or other damage, you must contact our company's sales window.
2. We may modify products or discontinue production of a product listed in this catalog without prior notification.
3. We provide "Delivery Specification" that explain precautions for the specifications and safety of each product listed in this catalog. We strongly recommend that you exchange these delivery specifications with customers that use one of these products.
4. If you plan to export a product listed in this catalog, keep in mind that it may be a restricted item according to the "Foreign Exchange and Foreign Trade Control Law". In such cases, it is necessary to acquire export permission in harmony with this law.
5. Any reproduction or transferring of the contents of this catalog is prohibited without prior permission from our company.
6. We are not responsible for problems that occur related to the intellectual property rights or other rights of our company or a third party when you use a product listed in this catalog. We do not grant license of these rights.
7. This catalog only applies to products purchased through our company or one of our company's official agencies. This catalog does not apply to products that are purchased through other third parties.



CKG Series Mega Cap Type Capacitors

Type: CKG32K, CKG45K, CKG57K, CKG45N, CKG57N

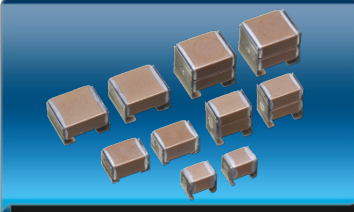

Features



- No polarity
- Twice the capacitance is obtainable on a single capacitor space
- Unique construction provides high reliability
- The metal caps absorb stress from thermal and mechanical shocks, ensuring excellent performance on aluminum circuit substrates
- Low ESR and ESL promise excellent characteristics for high frequency switching power supply

Applications



- Smoothing circuits
- Temperature variable applications
- Maintenance free power supplies
- DC to DC converters
- Automotive applications

Structure

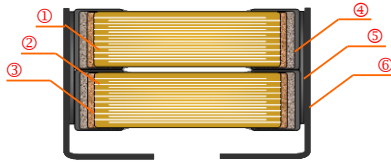

No.	Name	Material
①	Dielectric	BaTiO ₃
②	Electrode	Ni
③	Termination	Cu
④	Termination	Ni-Sn
⑤	Metal Cap Joint	High Temp Solder
⑥	Metal Cap	42 Alloy

Shape & Dimensions

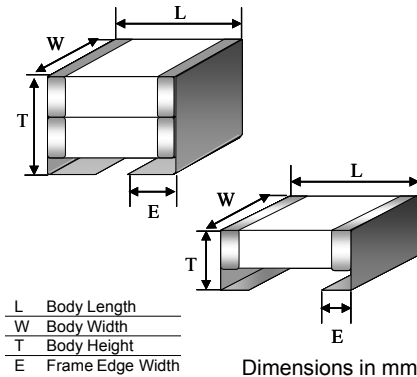

L	Body Length
W	Body Width
T	Body Height
E	Frame Edge Width

Dimensions in mm

Part Number Construction

Series Name: **CKG32K X7R 1E 106 M T XXXX**

Series Name

Case Code	Length	Width
CKG32K	3.60 ± 0.30	2.60 ± 0.30
CKG45K	5.00 ± 0.50	3.50 ± 0.50
CKG57K	6.00 ± 0.50	5.00 ± 0.50
CKG45N	5.00 ± 0.50	3.50 ± 0.50
CKG57N	6.00 ± 0.50	5.00 ± 0.50

Temperature Characteristic

Temperature Characteristics	Capacitance Change	Temperature Range
X5R	± 15%	-55 to +85°C
X7R	± 15%	-55 to +125°C
X7S	± 22%	-55 to +125°C
X7T	+22/-33%	-55 to +125°C

Rated Voltage (DC)

Voltage Code	Voltage (DC)
1C	16V
1E	25V
1H	50V
2A	100V
2E	250V
2W	450V
2J	630V

Internal Codes

Packaging Style

Packaging Code	Style
T	Tape & Reel

Capacitance Tolerance

Tolerance Code	Tolerance
M	± 20%

Nominal Capacitance (pF)

The capacitance is expressed in three digit codes and in units of pico Farads (pF). The first and second digits identify the first and second significant figures of the capacitance. The third digit identifies the multiplier. R designates a decimal point.

Capacitance Code	Capacitance
0R5	0.5pF
010	1pF
102	1,000pF (1nF)
105	1,000,000pF (1µF)



Capacitance Range Chart

CKG32K [Single Stack]

Capacitance Range Chart

Temperature Characteristics: X7R ($\pm 15\%$), X7S (± 22), X7T ($+22/-33$)
 Rated Voltage: 630V (2J), 450 (2W), 250V (2E), 100V (2A), 50V (1H), 25V (1E)

Capacitance (pF)	Cap Code	Tolerance	X7R					X7S		X7T			
			2J (630V)	2E (250V)	2A (100V)	1H (50V)	1E (25V)	2A (100V)	1H (50V)	2J (630V)	2W (450V)	2E (250V)	
47,000	473	M: $\pm 20\%$	█										
100,000	104				█								
150,000	154										█		
220,000	224											█	
330,000	334												█
470,000	474					█	█						
1,000,000	105					█							
2,200,000	225												
4,700,000	475								█	█			
10,000,000	106								█				

Standard Thickness

█ 3.35 mm



Capacitance Range Table

CKG32K [Single Stack]

Class 2 (Temperature Stable)

Temperature Characteristics: X7R (-55 to $+125^{\circ}\text{C}$, $\pm 15\%$), X7S (-55 to $+125^{\circ}\text{C}$, $\pm 22\%$), X7T (-55 to $+125^{\circ}\text{C}$, $+22/-33\%$)

TDK Part Number (Ordering Code)	Temperature Characteristics	Rated Voltage	Capacitance (pF)	Capacitance Tolerance	Thickness (mm)
CKG32KX7R1E475M	X7R	25V	4,700,000	$\pm 20\%$	3.35 \pm 0.15
CKG32KX7R1E106M	X7R	25V	10,000,000	$\pm 20\%$	3.35 \pm 0.15
CKG32KX7R1H105M	X7R	50V	1,000,000	$\pm 20\%$	3.35 \pm 0.15
CKG32KX7R2A474M	X7R	100V	470,000	$\pm 20\%$	3.35 \pm 0.15
CKG32KX7R2A105M	X7R	100V	1,000,000	$\pm 20\%$	3.35 \pm 0.15
CKG32KX7R2A225M	X7R	100V	2,200,000	$\pm 20\%$	3.35 \pm 0.15
CKG32KX7R2E104M	X7R	250V	100,000	$\pm 20\%$	3.35 \pm 0.15
CKG32KX7R2E224M	X7R	250V	220,000	$\pm 20\%$	3.35 \pm 0.15
CKG32KX7R2J473M	X7R	630V	47,000	$\pm 20\%$	3.35 \pm 0.15
CKG32KX7S1H475M	X7S	50V	4,700,000	$\pm 20\%$	3.35 \pm 0.15
CKG32KX7S1H106M	X7S	50V	10,000,000	$\pm 20\%$	3.35 \pm 0.15
CKG32KX7S2A475M	X7S	100V	4,700,000	$\pm 20\%$	3.35 \pm 0.15
CKG32KX7T2E334M	X7T	250V	330,000	$\pm 20\%$	3.35 \pm 0.15
CKG32KX7T2W224M	X7T	450V	220,000	$\pm 20\%$	3.35 \pm 0.15
CKG32KX7T2J154M	X7T	630V	150,000	$\pm 20\%$	3.35 \pm 0.15



Capacitance Range Chart

CKG45K [Single Stack]

Capacitance Range Chart

Temperature Characteristics: X7R ($\pm 15\%$), X7S (± 22), X7T (+22/-33)
 Rated Voltage: 630V (2J), 450 (2W), 250V (2E), 100V (2A), 50V (1H), 25V (1E), 16V (1C)

Capacitance (pF)	Cap Code	Tolerance	X7R						X7S	X7T		
			2J (630V)	2E (250V)	2A (100V)	1H (50V)	1E (25V)	1C (16V)	2A (100V)	2J (630V)	2W (450V)	2E (250V)
100,000	104	M: $\pm 20\%$	█									
220,000	224			█						█		
470,000	474				█						█	
1,000,000	105					█						█
2,200,000	225						█					
3,300,000	335							█				
4,700,000	475								█			
10,000,000	106									█		
22,000,000	226											

Standard Thickness

█ 2.90 mm



Capacitance Range Table

CKG45K [Single Stack]

Class 2 (Temperature Stable)

Temperature Characteristics: X7R (-55 to +125°C, $\pm 15\%$), X7S (-55 to +125°C, $\pm 22\%$), X7T (-55 to +125°C, +22/-33%)

TDK Part Number (Ordering Code)	Temperature Characteristics	Rated Voltage	Capacitance (pF)	Capacitance Tolerance	Thickness (mm)
CKG45KX7R1C106M	X7R	16V	10,000,000	$\pm 20\%$	2.90 \pm 0.10
CKG45KX7R1C226M	X7R	16V	22,000,000	$\pm 20\%$	2.90 \pm 0.10
CKG45KX7R1E475M	X7R	25V	4,700,000	$\pm 20\%$	2.90 \pm 0.10
CKG45KX7R1H335M	X7R	50V	3,300,000	$\pm 20\%$	2.90 \pm 0.10
CKG45KX7R1H475M	X7R	50V	4,700,000	$\pm 20\%$	2.90 \pm 0.10
CKG45KX7R2A105M	X7R	100V	1,000,000	$\pm 20\%$	2.90 \pm 0.10
CKG45KX7R2A225M	X7R	100V	2,200,000	$\pm 20\%$	2.90 \pm 0.10
CKG45KX7R2E224M	X7R	250V	220,000	$\pm 20\%$	2.90 \pm 0.10
CKG45KX7R2E474M	X7R	250V	470,000	$\pm 20\%$	2.90 \pm 0.10
CKG45KX7R2J104M	X7R	630V	100,000	$\pm 20\%$	2.90 \pm 0.10
CKG45KX7S2A475M	X7S	100V	4,700,000	$\pm 20\%$	2.90 \pm 0.10
CKG45KX7T2E105M	X7T	250V	1,000,000	$\pm 20\%$	2.90 \pm 0.10
CKG45KX7T2W474M	X7T	450V	470,000	$\pm 20\%$	2.90 \pm 0.10
CKG45KX7T2J224M	X7T	630V	220,000	$\pm 20\%$	2.90 \pm 0.10



Capacitance Range Chart

CKG57K [Single Stack]

Capacitance Range Chart

Temperature Characteristics: X7R ($\pm 15\%$), X7S (± 22), X7T (+22/-33)
 Rated Voltage: 630V (2J), 450 (2W), 250V (2E), 100V (2A), 50V (1H), 25V (1E), 16V (1C)

Capacitance (pF)	Cap Code	Tolerance	X7R						X7S	X7T		
			2J (630V)	2E (250V)	2A (100V)	1H (50V)	1E (25V)	1C (16V)	2A (100V)	2J (630V)	2W (450V)	2E (250V)
220,000	224	M: $\pm 20\%$	█									
470,000	474			█						█		
1,000,000	105				█						█	
2,200,000	225					█						█
3,300,000	335						█					
4,700,000	475							█				
10,000,000	106								█			
22,000,000	226									█		
47,000,000	476										█	

Standard Thickness

█ 3.35 mm



Capacitance Range Table

CKG57K [Single Stack]

Class 2 (Temperature Stable)

Temperature Characteristics: X7R (-55 to +125°C, $\pm 15\%$), X7S (-55 to +125°C, $\pm 22\%$), X7T (-55 to +125°C, +22/-33%)

TDK Part Number (Ordering Code)	Temperature Characteristics	Rated Voltage	Capacitance (pF)	Capacitance Tolerance	Thickness (mm)
CKG57KX7R1C476M	X7R	16V	47,000,000	$\pm 20\%$	3.35 \pm 0.15
CKG57KX7R1E106M	X7R	25V	10,000,000	$\pm 20\%$	3.35 \pm 0.15
CKG57KX7R1E226M	X7R	25V	22,000,000	$\pm 20\%$	3.35 \pm 0.15
CKG57KX7R1H475M	X7R	50V	4,700,000	$\pm 20\%$	3.35 \pm 0.15
CKG57KX7R1H106M	X7R	50V	10,000,000	$\pm 20\%$	3.35 \pm 0.15
CKG57KX7R2A105M	X7R	100V	1,000,000	$\pm 20\%$	3.35 \pm 0.15
CKG57KX7R2A225M	X7R	100V	2,200,000	$\pm 20\%$	3.35 \pm 0.15
CKG57KX7R2A335M	X7R	100V	3,300,000	$\pm 20\%$	3.35 \pm 0.15
CKG57KX7R2A475M	X7R	100V	4,700,000	$\pm 20\%$	3.35 \pm 0.15
CKG57KX7R2E474M	X7R	250V	470,000	$\pm 20\%$	3.35 \pm 0.15
CKG57KX7R2E105M	X7R	250V	1,000,000	$\pm 20\%$	3.35 \pm 0.15
CKG57KX7R2J224M	X7R	630V	220,000	$\pm 20\%$	3.35 \pm 0.15
CKG57KX7S2A106M	X7S	100V	10,000,000	$\pm 20\%$	3.35 \pm 0.15
CKG57KX7T2E225M	X7T	250V	2,200,000	$\pm 20\%$	3.35 \pm 0.15
CKG57KX7T2W105M	X7T	450V	1,000,000	$\pm 20\%$	3.35 \pm 0.15
CKG57KX7T2J474M	X7T	630V	470,000	$\pm 20\%$	3.35 \pm 0.15



Capacitance Range Chart

CKG45N [Double Stack]

Capacitance Range Chart

Temperature Characteristics: X7R ($\pm 15\%$), X7S (± 22), X7T (+22/-33), X5R ($\pm 15\%$)
 Rated Voltage: 630V (2J), 450 (2W), 250V (2E), 100V (2A), 50V (1H), 25V (1E), 16V (1C)

Capacitance (pF)	Cap Code	Tolerance	X7R						X7T		
			2J (630V)	2E (250V)	2A (100V)	1H (50V)	1E (25V)	1C (16V)	2J (630V)	2W (450V)	2E (250V)
220,000	224	M: $\pm 20\%$	█								
470,000	474			█					█		
1,000,000	105				█					█	
2,200,000	225					█					█
3,300,000	335						█				
4,700,000	475					█					
6,800,000	685						█				
10,000,000	106							█			
22,000,000	226								█		
47,000,000	476									█	

Capacitance (pF)	Cap Code	Tolerance	X7S			X5R	
			2A (100V)	1H (50V)	1C (16V)	1H (50V)	1C (16V)
4,700,000	475	M: $\pm 20\%$					
6,800,000	685						
10,000,000	106		█	█		█	
22,000,000	226						
47,000,000	476				█		█

Standard Thickness
 5.00 mm



Capacitance Range Table

CKG45N [Double Stack]

Class 2 (Temperature Stable)

Temperature Characteristics: X7R (-55 to +125°C, $\pm 15\%$), X7S (-55 to +125°C, $\pm 22\%$),
 X7T (-55 to +125°C, +22/-33%), X5R (-55 to +85°C, $\pm 15\%$)

TDK Part Number (Ordering Code)	Temperature Characteristics	Rated Voltage	Capacitance (pF)	Capacitance Tolerance	Thickness (mm)
CKG45NX5R1C476M	X5R	16V	47,000,000	$\pm 20\%$	5.00 \pm 0.50
CKG45NX5R1H106M	X5R	50V	10,000,000	$\pm 20\%$	5.00 \pm 0.50
CKG45NX7R1C226M	X7R	16V	22,000,000	$\pm 20\%$	5.00 \pm 0.50
CKG45NX7R1E106M	X7R	25V	10,000,000	$\pm 20\%$	5.00 \pm 0.50
CKG45NX7R1H335M	X7R	50V	3,300,000	$\pm 20\%$	5.00 \pm 0.50
CKG45NX7R1H685M	X7R	50V	6,800,000	$\pm 20\%$	5.00 \pm 0.50
CKG45NX7R2A225M	X7R	100V	2,200,000	$\pm 20\%$	5.00 \pm 0.50
CKG45NX7R2A475M	X7R	100V	4,700,000	$\pm 20\%$	5.00 \pm 0.50
CKG45NX7R2E474M	X7R	250V	470,000	$\pm 20\%$	5.00 \pm 0.50
CKG45NX7R2E105M	X7R	250V	1,000,000	$\pm 20\%$	5.00 \pm 0.50
CKG45NX7R2J224M	X7R	630V	220,000	$\pm 20\%$	5.00 \pm 0.50
CKG45NX7S1C476M	X7S	16V	47,000,000	$\pm 20\%$	5.00 \pm 0.50
CKG45NX7S1H106M	X7S	50V	10,000,000	$\pm 20\%$	5.00 \pm 0.50
CKG45NX7S2A106M	X7S	100V	10,000,000	$\pm 20\%$	5.00 \pm 0.50
CKG45NX7T2E225M	X7T	250V	2,200,000	$\pm 20\%$	5.00 \pm 0.50
CKG45NX7T2W105M	X7T	450V	1,000,000	$\pm 20\%$	5.00 \pm 0.50
CKG45NX7T2J474M	X7T	630V	470,000	$\pm 20\%$	5.00 \pm 0.50



Capacitance Range Chart

CKG57N [Double Stack]

Capacitance Range Chart

Temperature Characteristics: X7R ($\pm 15\%$), X7S (± 22), X7T (+22/-33), X5R ($\pm 15\%$)
 Rated Voltage: 630V (2J), 450 (2W), 250V (2E), 100V (2A), 50V (1H), 25V (1E), 16V (1C)

Capacitance (pF)	Cap Code	Tolerance	X7R						X7T		
			2J (630V)	2E (250V)	2A (100V)	1H (50V)	1E (25V)	1C (16V)	2J (630V)	2W (450V)	2E (250V)
470,000	474	M: $\pm 20\%$	█								
1,000,000	105			█					█		
2,200,000	225				█					█	
3,300,000	335					█					█
4,700,000	475					█					
10,000,000	106						█				
22,000,000	226							█			
33,000,000	336								█		
47,000,000	476									█	
100,000,000	107										█

Capacitance (pF)	Cap Code	Tolerance	X7S				X5R		
			2A (100V)	1H (50V)	1E (25V)	1C (16V)	1H (50V)	1E (25V)	1C (16V)
10,000,000	106	M: $\pm 20\%$	█	█					
22,000,000	226						█		
33,000,000	336							█	
47,000,000	476					█			█
100,000,000	107						█		█

Standard Thickness
 5.00 mm



Capacitance Range Table

CKG57N [Double Stack]

Class 2 (Temperature Stable)

Temperature Characteristics: X7R (-55 to +125°C, $\pm 15\%$), X7S (-55 to +125°C, $\pm 22\%$), X7T (-55 to +125°C, +22/-33%)

TDK Part Number (Ordering Code)	Temperature Characteristics	Rated Voltage	Capacitance (pF)	Capacitance Tolerance	Thickness (mm)
CKG57NX5R1C107M	X5R	16V	100,000,000	$\pm 20\%$	5.00 \pm 0.50
CKG57NX5R1E476M	X5R	25V	47,000,000	$\pm 20\%$	5.00 \pm 0.50
CKG57NX5R1H226M	X5R	50V	22,000,000	$\pm 20\%$	5.00 \pm 0.50
CKG57NX7R1C336M	X7R	16V	33,000,000	$\pm 20\%$	5.00 \pm 0.50
CKG57NX7R1E226M	X7R	25V	22,000,000	$\pm 20\%$	5.00 \pm 0.50
CKG57NX7R1H106M	X7R	50V	10,000,000	$\pm 20\%$	5.00 \pm 0.50
CKG57NX7R2A225M	X7R	100V	2,200,000	$\pm 20\%$	5.00 \pm 0.50
CKG57NX7R2A475M	X7R	100V	4,700,000	$\pm 20\%$	5.00 \pm 0.50
CKG57NX7R2A106M	X7R	100V	10,000,000	$\pm 20\%$	5.00 \pm 0.50
CKG57NX7R2E105M	X7R	250V	1,000,000	$\pm 20\%$	5.00 \pm 0.50
CKG57NX7R2E225M	X7R	250V	2,200,000	$\pm 20\%$	5.00 \pm 0.50
CKG57NX7R2J474M	X7R	630V	470,000	$\pm 20\%$	5.00 \pm 0.50
CKG57NX7S1C107M	X7S	16V	100,000,000	$\pm 20\%$	5.00 \pm 0.50
CKG57NX7S1E476M	X7S	25V	47,000,000	$\pm 20\%$	5.00 \pm 0.50
CKG57NX7S1H226M	X7S	50V	22,000,000	$\pm 20\%$	5.00 \pm 0.50
CKG57NX7S2A226M	X7S	100V	22,000,000	$\pm 20\%$	5.00 \pm 0.50
CKG57NX7T2E335M	X7T	250V	3,300,000	$\pm 20\%$	5.00 \pm 0.50
CKG57NX7T2W225M	X7T	450V	2,200,000	$\pm 20\%$	5.00 \pm 0.50
CKG57NX7T2J105M	X7T	630V	1,000,000	$\pm 20\%$	5.00 \pm 0.50



General Specifications

CKG Series – Mega Cap Type Capacitors

No.	Item	Performance	Test or Inspection Method										
1	External Appearance	No defects which may affect performance.	Inspect with magnifying glass (3×).										
2	Insulation Resistance	500MΩ•μF min. (As for the capacitors of rated voltage 16V DC, 100MΩ•μF min.), whichever smaller.	Apply rated voltage for 60s. As for the rated voltage 630V DC, apply 500V DC.										
3	Voltage Proof	Withstand test voltage without insulation breakdown or other damage.	<table border="1"> <thead> <tr> <th>Rated Voltage</th> <th>Apply voltage</th> </tr> </thead> <tbody> <tr> <td>100V and under</td> <td>2.5 × rated voltage</td> </tr> <tr> <td>Over 100V</td> <td>1.5 × rated voltage</td> </tr> </tbody> </table>	Rated Voltage	Apply voltage	100V and under	2.5 × rated voltage	Over 100V	1.5 × rated voltage				
			Rated Voltage	Apply voltage									
100V and under	2.5 × rated voltage												
Over 100V	1.5 × rated voltage												
			Above DC voltage shall be applied for 1 to 5s. Charge / discharge current shall not exceed 50mA.										
4	Capacitance	Within the specified tolerance.	<table border="1"> <thead> <tr> <th>Rated Capacitance</th> <th>Measuring Frequency</th> <th>Measuring voltage</th> </tr> </thead> <tbody> <tr> <td>10uF and under</td> <td>1kHz±10%</td> <td>1.0±0.2V_{rms}</td> </tr> <tr> <td>Over 10uF</td> <td>120Hz±20%</td> <td>0.5±0.2 V_{rms}</td> </tr> </tbody> </table>	Rated Capacitance	Measuring Frequency	Measuring voltage	10uF and under	1kHz±10%	1.0±0.2V _{rms}	Over 10uF	120Hz±20%	0.5±0.2 V _{rms}	
			Rated Capacitance	Measuring Frequency	Measuring voltage								
10uF and under	1kHz±10%	1.0±0.2V _{rms}											
Over 10uF	120Hz±20%	0.5±0.2 V _{rms}											
			See No.4 in this table for measuring condition.										
5	Dissipation Factor (Class 2)	<table border="1"> <thead> <tr> <th>T.C.</th> <th>D.F.</th> </tr> </thead> <tbody> <tr> <td>X5R</td> <td>0.045 max.</td> </tr> <tr> <td>X7R</td> <td>0.045 max.</td> </tr> <tr> <td>X7S</td> <td>0.075 max.</td> </tr> <tr> <td>X7T</td> <td>0.010 max.</td> </tr> </tbody> </table>	T.C.	D.F.	X5R	0.045 max.	X7R	0.045 max.	X7S	0.075 max.	X7T	0.010 max.	
		T.C.	D.F.										
		X5R	0.045 max.										
		X7R	0.045 max.										
		X7S	0.075 max.										
X7T	0.010 max.												
6	Temperature Characteristics of Capacitance	Capacitance Change (%)	Capacitance shall be measured by the steps shown in the following table after thermal equilibrium is obtained for each step. ΔC be calculated ref. STEP3 reading										
		<table border="1"> <thead> <tr> <th>No Voltage Applied</th> </tr> </thead> <tbody> <tr> <td>X5R: ± 15%</td> </tr> <tr> <td>X7R: ± 15%</td> </tr> <tr> <td>X7S: ± 22%</td> </tr> <tr> <td>X7T: + 22/-33%</td> </tr> </tbody> </table>		No Voltage Applied	X5R: ± 15%	X7R: ± 15%	X7S: ± 22%	X7T: + 22/-33%					
		No Voltage Applied											
		X5R: ± 15%											
		X7R: ± 15%											
X7S: ± 22%													
X7T: + 22/-33%													
7	Robustness of Terminations	No sign of termination coming off, breakage of ceramic, or other abnormal signs.	Reflow solder the capacitors on P.C. board (shown in Appendix 1) and apply a pushing force of 5N with 10±1s.										

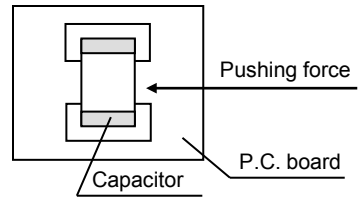



CKG Series – Mega Cap Type Capacitors

No.	Item	Performance	Test or Inspection Method															
8	Bending	No mechanical damage.	<p>Reflow solder the capacitor on P.C. board (shown in Appendix 2) and bend it for 1mm.</p> <p style="text-align: right;">Unit: mm</p>															
9	Solderability	<p>Both end faces and the contact areas shall be covered with a smooth and bright solder coating with no more than a small amount of scattered imperfections such as pinholes or un-wetted or de-wetted areas.</p> <p>These imperfections shall not be concentrated in one area.</p>	<p>Reflow solder the capacitors on P.C board (shown in Appendix 1).</p> <p>Solder: H63A (JIS Z 3282)</p> <p>Flux: Isopropyl alcohol (JIS K 8839) Rosin (JIS K 5902) 25% solid solution.</p>															
10	Temperature Cycle	No mechanical damage.	<p>Reflow solder the capacitors on P.C. board (shown in Appendix 1) before testing.</p> <p>Expose the capacitors in the condition step1 through step 4 and repeat 100 times consecutively.</p> <p>Leave the capacitors in ambient condition for 24 ± 2h before measurement.</p> <table border="1"> <thead> <tr> <th>Step</th> <th>Temperature (°C)</th> <th>Time (min.)</th> </tr> </thead> <tbody> <tr> <td>1</td> <td>Min. operating temp. ± 3</td> <td>30 ± 3</td> </tr> <tr> <td>2</td> <td>Reference Temp. ± 2</td> <td>2 – 5</td> </tr> <tr> <td>3</td> <td>Max. operating temp. ± 2</td> <td>30 ± 2</td> </tr> <tr> <td>4</td> <td>Reference Temp. ± 2</td> <td>2 - 5</td> </tr> </tbody> </table>	Step	Temperature (°C)	Time (min.)	1	Min. operating temp. ± 3	30 ± 3	2	Reference Temp. ± 2	2 – 5	3	Max. operating temp. ± 2	30 ± 2	4	Reference Temp. ± 2	2 - 5
Step	Temperature (°C)	Time (min.)																
1	Min. operating temp. ± 3	30 ± 3																
2	Reference Temp. ± 2	2 – 5																
3	Max. operating temp. ± 2	30 ± 2																
4	Reference Temp. ± 2	2 - 5																
	External appearance	No mechanical damage.																
	Capacitance	<table border="1"> <thead> <tr> <th>Characteristics</th> <th>Change from the value before test</th> </tr> </thead> <tbody> <tr> <td>X5R</td> <td rowspan="4">$\pm 7.5 \%$</td> </tr> <tr> <td>X7R</td> </tr> <tr> <td>X7S</td> </tr> <tr> <td>X7T</td> </tr> </tbody> </table>	Characteristics	Change from the value before test	X5R	$\pm 7.5 \%$	X7R	X7S	X7T									
Characteristics	Change from the value before test																	
X5R	$\pm 7.5 \%$																	
X7R																		
X7S																		
X7T																		
	D.F.	Meet the initial spec.																
	Insulation Resistance	Meet the initial spec.																
	Voltage Proof	No insulation breakdown or other damage.																



General Specifications

CKG Series – Mega Cap Type Capacitors

No.	Item	Performance	Test or Inspection Method							
14	Moisture Resistance									
	External appearance	No mechanical damage.	Reflow solder the capacitors on a P.C. board (shown in Appendix 1) before testing.							
	Capacitance	<table border="1"> <thead> <tr> <th>Characteristics</th> <th>Change from the value before test</th> </tr> </thead> <tbody> <tr> <td>X5R</td> <td rowspan="4">± 12.5 %</td> </tr> <tr> <td>X7R</td> </tr> <tr> <td>X7S</td> </tr> <tr> <td>X7T</td> </tr> </tbody> </table>	Characteristics	Change from the value before test	X5R	± 12.5 %	X7R	X7S	X7T	Apply the rated voltage at temperature 40±2°C and 90 to 95%RH for 500+24,0h.
			Characteristics	Change from the value before test						
			X5R	± 12.5 %						
X7R										
X7S										
X7T										
		Charge/discharge current shall not exceed 50mA.								
		Leave the capacitor in ambient conditions for 24±2h before measurement.								
D.F. (Class 2)	Characteristics X5R/X7R/X7S/X7T: 200% of initial spec. max.	Voltage conditioning: Voltage treats the capacitor under testing temperature and voltage for 1 hour.	Leave the capacitor in ambient conditions for 24±2h before measurement.							
Insulation Resistance	25MΩ•μF min. (As for the capacitors of rated voltage 16V DC, 5MΩ•μF min.).		Use this measurement for initial value.							
15	Life									
	External appearance	No mechanical damage.	Reflow solder the capacitors on a P.C. Board shown in Appendix 1 before testing.							
	Capacitance	<table border="1"> <thead> <tr> <th>Characteristics</th> <th>Change from the value before test</th> </tr> </thead> <tbody> <tr> <td>X5R</td> <td rowspan="4">± 15 %</td> </tr> <tr> <td>X7R</td> </tr> <tr> <td>X7S</td> </tr> <tr> <td>X7T</td> </tr> </tbody> </table>	Characteristics	Change from the value before test	X5R	± 15 %	X7R	X7S	X7T	Below the voltage shall be applied at Maximum operating temperature ±2°C for 1,000 +48, 0h.
			Characteristics	Change from the value before test						
			X5R	± 15 %						
X7R										
X7S										
X7T										
		Applied voltage is 1xRV. Some items may be tested at higher voltage (1.2x, 1.5x or 2x RV).								
		Charge/discharge current shall not exceed 50mA.								
D.F. (Class 2)	Characteristics X5R/X7R/X7S/X7T: 200% of initial spec. max.	Voltage conditioning: Voltage treat the capacitors under testing temperature and voltage for 1 hour.	Leave the capacitors in ambient condition for 24±2h before measurement.							
Insulation Resistance	50MΩ•μF min. (As for the capacitors of rated voltage 16V DC, 10MΩ•μF min.).		Leave the capacitors in ambient condition for 24±2h before measurement. Use this measurement for initial value.							

***As for the initial measurement of capacitors on number 6 and 10, leave capacitors at 150 –10, 0°C for 1 hour and measure the value after leaving capacitors for 24±2h in ambient condition.**



Appendix - 1

P.C. Board for reliability test

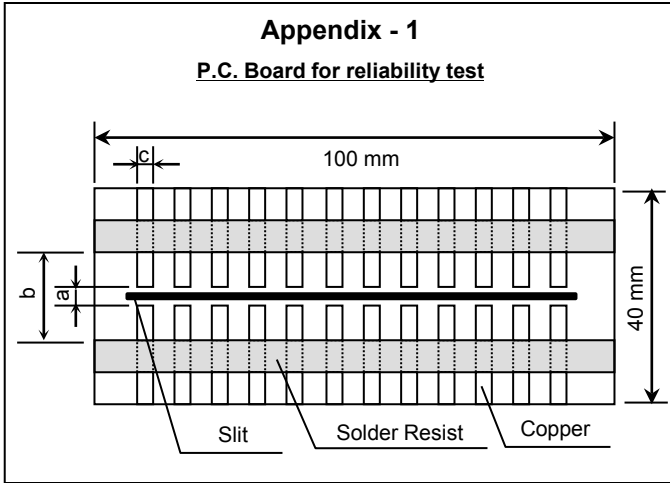

Appendix - 2

P.C. Board for bending test

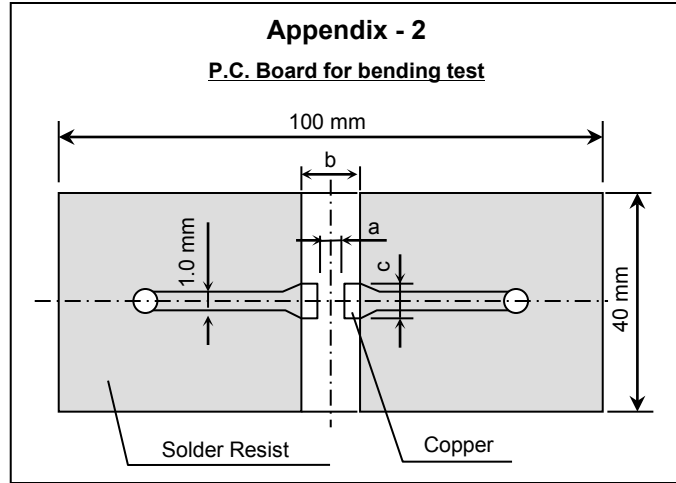

Material: Glass Epoxy (As per JIS C6484 GE4)

P.C. Board thickness: 1.6mm

- Copper (thickness 0.035mm)
- Solder resist

Series	Dimensions (mm)		
	a	b	c
CKG32K	2.2	5.0	2.9
CKG45K	3.5	6.1	2.9
CKG57K	4.1	7.6	4.7
CKG45N	3.5	6.1	2.9
CKG57N	4.1	7.6	4.7

Soldering Information

CKG Series – Mega Cap Type Capacitors

Recommended Soldering Land Pattern

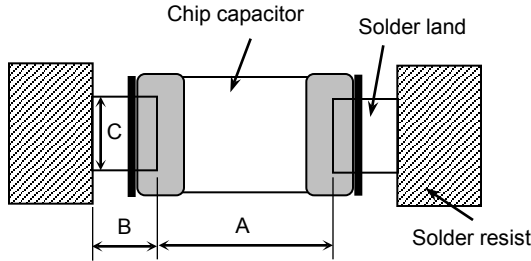

Reflow Soldering Unit: mm

Type	CKG32K	CKG45K/ CKG45N	CKG57K/ CKG57N
A	2.0 ~ 2.2	3.3 ~ 3.7	3.9 ~ 4.3
B	1.1 ~ 1.3	1.2 ~ 1.5	1.5 ~ 2.0
C	2.3 ~ 2.5	2.7 ~ 3.2	4.5 ~ 5.0

Recommended Solder Amount

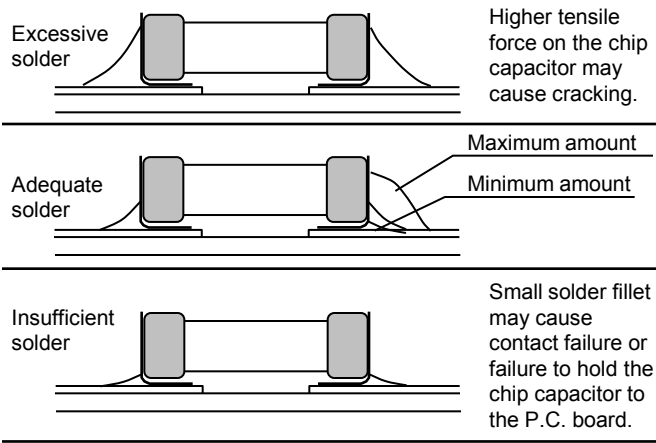

Recommended Soldering Profile

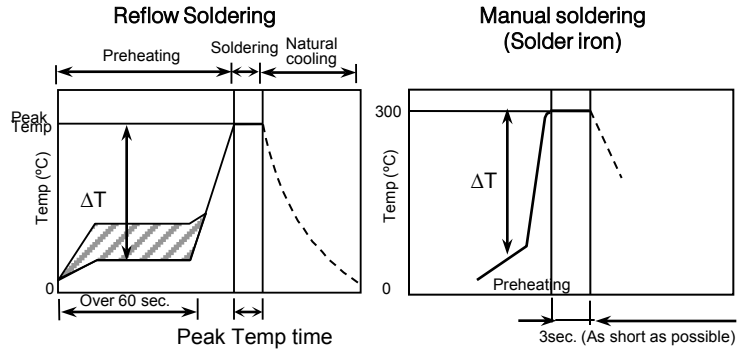

Recommended soldering duration

Solder	Temp./Dura.	Reflow Soldering	
		Peak temp (°C)	Duration (sec.)
Sn-Pb Solder		230 max.	20 max.
Lead-Free Solder		250 max.	10 max.

Recommended solder compositions

- Sn-37Pb (Sn-Pb solder)
- Sn-3.0Ag-0.5Cu (Lead Free Solder)

Preheating Condition

Soldering Method	Temperature (°C)
Reflow soldering	$\Delta T \leq 130$
Manual soldering	$\Delta T \leq 130$



Packaging Information

CKG Series – Mega Cap Type Capacitors

Carrier Tape Configuration

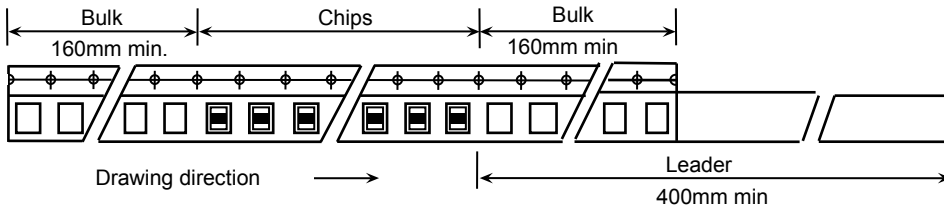

Peel Back Force (Top Tape)

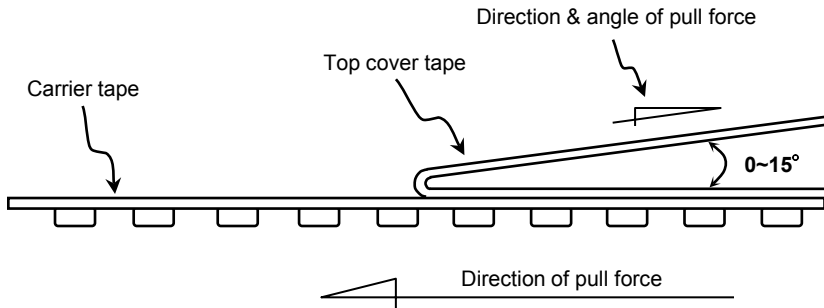

- Carrier tape shall be flexible enough to be wound around a minimum radius of 30mm with components in tape.
- The missing of components shall be less than 0.1%
- Components shall not stick to the cover tape.
- The cover tape shall not protrude beyond the edges of the carrier tape and shall not cover the sprocket holes.

Chip Quantity Per Reel and Structure of Reel

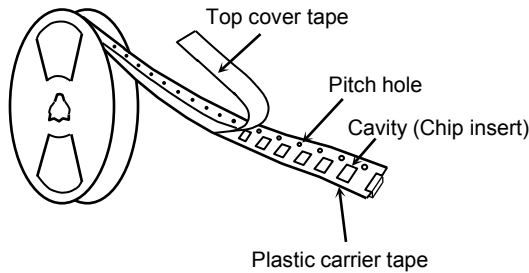

Series	Taping Material	Chip quantity (pcs.)	
		φ178mm (7") reel	φ330mm (13") reel
CKG32K	Plastic	1,000	4,000
CKG45K		-	1,000
CKG57K			
CKG45N			
CKG57N			



Additional Information

CKG Series – Mega Cap Type Capacitors

• Inside Structure & Material System

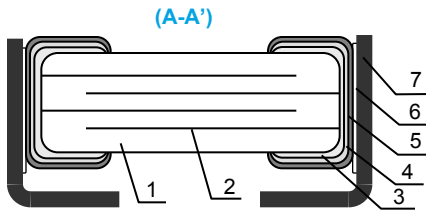
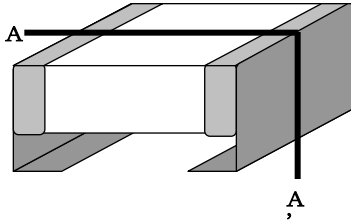

No.	NAME	MATERIAL	
		Class 1	Class 2
(1)	Ceramic Dielectric	CaZrO ₃	BaTiO ₃
(2)	Internal Electrode	Nickel (Ni)	
(3)		Copper (Cu)	
(4)	Termination	Nickel (Ni)	
(5)		Tin (Sn)	
(6)	Metal Cap Joint	High Temp Solger	
(7)	Metal Cap	42 Alloy	

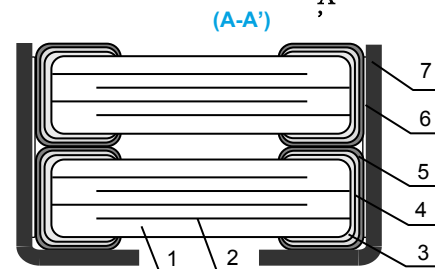
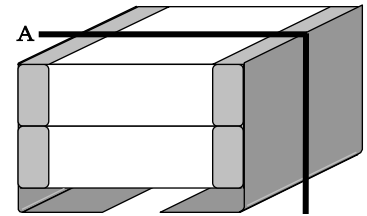

• Shape & Dimensions

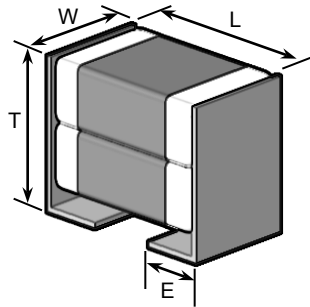
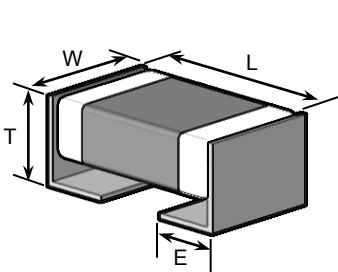

Case Code / Series	Dimensions (mm)			
	L	W	T	E
CKG32K	3.60 ± 0.30	2.60 ± 0.30	3.35 ± 0.10	0.80 ± 0.15
CKG45K	5.00 ± 0.50	3.50 ± 0.50	2.90 ± 0.10	1.10 ± 0.30
CKG57K	6.00 ± 0.50	5.00 ± 0.50	3.35 ± 0.15	1.60 ± 0.30
CKG45N	5.00 ± 0.50	3.50 ± 0.50	5.00 ± 0.50	1.10 ± 0.30
CKG57N	6.00 ± 0.50	5.00 ± 0.50	5.00 ± 0.50	1.60 ± 0.30

• Environmental Information

TDK Corporation established internal product environmental assurance standards that include the six hazardous substances banned by the EU RoHS Directive¹ enforced on July 1, 2006 along with additional substances independently banned by TDK and has successfully completed making general purpose electronic components conform to the RoHS Directive².

1. Abbreviation for Restriction on Hazardous Substances, which refers to the regulation EU Directive 2002/95/EC on hazardous substances by the European Union (EU) effective from July 1, 2006. The Directive bans the use of six specific hazardous substances in electric and electronic devices and products handled within the EU. The six substances are lead, mercury, cadmium, hexavalent chromium, PBB (polybrominated biphenyls), and PBDE (polybrominated diphenyl ethers).
2. This means that, in conformity with the EU Directive 2002/95/EC, lead, cadmium, mercury, hexavalent chromium, and specific bromine-based flame retardants, PBB and PBDE, have not been used, except for exempted applications.

For REACH (SVHC : 15 substances according to ECHA / October 2008) : All TDK MLCC do not contain these 15 substances.

For European Directive 2000/53/CE and 2005/673/CE : Cadmium, Hexavalent Chromium, Mercury, Lead are not contained in all TDK MLCC.

For European Directive 2003/11/CE : Pentabromodiphenyl-ether, Octabromodiphenyl-ether are not contained in all TDK MLCC.