



MULTILAYER CERAMIC CHIP CAPACITORS



CLL Series Ultra Low Inductance Capacitors

Type: CLLC1A
CLLE1A

Issue date: April 2011

**TDK MLCC
US Catalog**

Version B11

REMINDERS

Please read before using this product

SAFETY REMINDERS



REMINDERS

1. If you intend to use a product listed in this catalog for a purpose that may cause loss of life or other damage, you must contact our company's sales window.
2. We may modify products or discontinue production of a product listed in this catalog without prior notification.
3. We provide "Delivery Specification" that explain precautions for the specifications and safety of each product listed in this catalog. We strongly recommend that you exchange these delivery specifications with customers that use one of these products.
4. If you plan to export a product listed in this catalog, keep in mind that it may be a restricted item according to the "Foreign Exchange and Foreign Trade Control Law". In such cases, it is necessary to acquire export permission in harmony with this law.
5. Any reproduction or transferring of the contents of this catalog is prohibited without prior permission from our company.
6. We are not responsible for problems that occur related to the intellectual property rights or other rights of our company or a third party when you use a product listed in this catalog. We do not grant license of these rights.
7. This catalog only applies to products purchased through our company or one of our company's official agencies. This catalog does not apply to products that are purchased through other third parties.



CLL Series

Ultra Low Inductance Capacitors

Type: CLLC1A (C1608), CLLE1A (C2012)

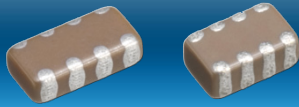

Features



- Features a unique internal structure that cancels magnetic fields to reduce equivalent series inductance
- Eight side terminal electrodes in one capacitor

Structure

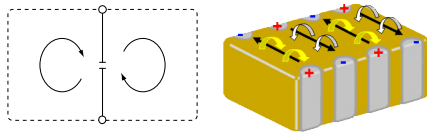

	ULI		FLIP	STD
Chip Size	C1608	C2012	C1632	C2012
Cap.	1 μ F	1 μ F	1 μ F	1 μ F
W.V.	0G (4V)	0G (4V)	1A (10V)	1A (10V)
ESL	65pH	70pH	180pH	850pH

Applications



- Decoupling CPU power line
- High speed digital IC/decoupling
- GPU/CPU

Shape & Dimensions

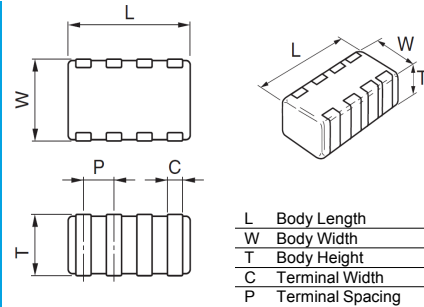

Dimensions in mm



Part Number Construction

CLLC1A X7R 0J 105 M T XXXX

Series Name

Case Code	Length	Width
CLLC1A	1.60 \pm 0.10	0.80 \pm 0.10
CLLE1A	2.00 \pm 0.15	1.25 \pm 0.15

Temperature Characteristic

Temperature Characteristics	Capacitance Change	Temperature Range
X7R	\pm 15%	-55 to +125°C
X7S	\pm 22%	-55 to +125°C

Rated Voltage (DC)

Voltage Code	Voltage (DC)
0G	4V
0J	6.3V
1A	10V

Internal Codes

Packaging Style

Packaging Code	Style
T	Tape & Reel

Capacitance Tolerance

Tolerance Code	Tolerance
M	\pm 20%

Nominal Capacitance (pF)

The capacitance is expressed in three digit codes and in units of pico Farads (pF). The first and second digits identify the first and second significant figures of the capacitance. The third digit identifies the multiplier. R designates a decimal point.

Capacitance Code	Capacitance
0R5	0.5pF
010	1pF
102	1,000pF (1nF)
105	1,000,000pF (1 μ F)







Capacitance Range Chart

CLLC1A [EIA CC0603]

Capacitance Range Chart

Temperature Characteristics: X7S (± 22)
 Rated Voltage: 4V (0G)

Capacitance (pF)	Cap Code	Tolerance	X7S
			0G (4V)
330,000	334	M: $\pm 20\%$	
470,000	474		
680,000	684		
1,000,000	105		

Standard Thickness
 0.50 mm



Capacitance Range Table

CLLC1A [EIA CC0603]

Class 2 (Temperature Stable)

Temperature Characteristics: X7S (-55 to +125°C, $\pm 22\%$)

TDK Part Number (Ordering Code)	Temperature Characteristics	Rated Voltage	Capacitance (pF)	Capacitance Tolerance	Thickness (mm)
CLLC1AX7S0G334M	X7S	4V	330,000	$\pm 20\%$	0.50 \pm 0.10
CLLC1AX7S0G474M	X7S	4V	470,000	$\pm 20\%$	0.50 \pm 0.10
CLLC1AX7S0G684M	X7S	4V	680,000	$\pm 20\%$	0.50 \pm 0.10
CLLC1AX7S0G105M	X7S	4V	1,000,000	$\pm 20\%$	0.50 \pm 0.10



Capacitance Range Chart

CLLE1A [EIA CC0805]

Capacitance Range Chart

Temperature Characteristics: X7R ($\pm 15\%$), X7S ($\pm 22\%$)
 Rated Voltage: 10V (1A), 6.3V (0J), 4V (0G)

Capacitance (pF)	Cap Code	Tolerance	X7R		X7S
			1A (10V)	0J (6.3V)	0G (4V)
100,000	104	M: $\pm 20\%$	█		
150,000	154		█		
220,000	224		█		
330,000	334		█		
470,000	474			█	
680,000	684			█	
1,000,000	105				█
1,500,000	155				█
2,200,000	225				█
4,700,000	475				█

Standard Thickness
█ 0.50 mm
█ 0.85 mm



Capacitance Range Table

CLLE1A [EIA CC0805]

Class 2 (Temperature Stable)

Temperature Characteristics: X7R (-55 to +125°C, $\pm 15\%$), X7S (-55 to +125°C, $\pm 22\%$)

TDK Part Number (Ordering Code)	Temperature Characteristics	Rated Voltage	Capacitance (pF)	Capacitance Tolerance	Thickness (mm)
CLLE1AX7R1A104M	X7R	10V	100,000	$\pm 20\%$	0.50 \pm 0.10
CLLE1AX7R1A154M	X7R	10V	150,000	$\pm 20\%$	0.50 \pm 0.10
CLLE1AX7R1A224M	X7R	10V	220,000	$\pm 20\%$	0.50 \pm 0.10
CLLE1AX7R1A334M	X7R	10V	330,000	$\pm 20\%$	0.50 \pm 0.10
CLLE1AX7R0J474M	X7R	6.3V	470,000	$\pm 20\%$	0.50 \pm 0.10
CLLE1AX7R0J684M	X7R	6.3V	680,000	$\pm 20\%$	0.50 \pm 0.10
CLLE1AX7R0J105M	X7R	6.3V	1,000,000	$\pm 20\%$	0.85 \pm 0.10
CLLE1AX7R0J155M	X7R	6.3V	1,500,000	$\pm 20\%$	0.85 \pm 0.10
CLLE1AX7S0G105M	X7S	4V	1,000,000	$\pm 20\%$	0.50 \pm 0.10
CLLE1AX7S0G155M	X7S	4V	1,500,000	$\pm 20\%$	0.50 \pm 0.10
CLLE1AX7S0G225M/0.50	X7S	4V	2,200,000	$\pm 20\%$	0.50 \pm 0.10
CLLE1AX7S0G225M/0.85	X7S	4V	2,200,000	$\pm 20\%$	0.85 \pm 0.10
CLLE1AX7S0G475M	X7S	4V	4,700,000	$\pm 20\%$	0.85 \pm 0.10



General Specifications

CLL Series – ULI Capacitors

No.	Item	Performance	Test or Inspection Method										
1	External Appearance	No defects which may affect performance.	Inspect with magnifying glass (3×).										
2	Insulation Resistance	100MΩ•μF min.	Apply rated voltage for 60s. Measure 8 terminal electrodes at the same time.										
3	Voltage Proof	Withstand test voltage without insulation breakdown or other damage.	2.5 times rated voltage (DC) shall be applied for 1 to 5s. Charge / discharge current shall not exceed 50mA. Measure 8 terminal electrodes at the same time.										
4	Capacitance	Within the specified tolerance at 1000hrs age (Per IEC-384-9).	<table border="1"> <thead> <tr> <th>Measuring Frequency</th> <th>Withstanding Voltage</th> <th>Measuring voltage</th> </tr> </thead> <tbody> <tr> <td rowspan="2">1kHz ± 10%</td> <td>10V</td> <td>1.0 ± 0.2 V_{rms}</td> </tr> <tr> <td>≤ 6.3V</td> <td>0.5 ± 0.2 V_{rms}</td> </tr> </tbody> </table>	Measuring Frequency	Withstanding Voltage	Measuring voltage	1kHz ± 10%	10V	1.0 ± 0.2 V _{rms}	≤ 6.3V	0.5 ± 0.2 V _{rms}		
			Measuring Frequency	Withstanding Voltage	Measuring voltage								
1kHz ± 10%	10V	1.0 ± 0.2 V _{rms}											
	≤ 6.3V	0.5 ± 0.2 V _{rms}											
			Measure 8 terminal electrodes at the same time.										
5	Dissipation Factor (Class 2)	T.C.	See No.4 in this table for measuring condition.										
		D.F.											
		X7R	0.10 max.										
		X7S											
6	Temperature Characteristics of Capacitance (Class 2)	Capacitance Change (%)	Capacitance shall be measured by the steps shown in the following table after thermal equilibrium is obtained for each step. ΔC be calculated ref. STEP 3 reading										
		No DC Voltage Applied											
		X7R: ± 15%	<table border="1"> <thead> <tr> <th>Step</th> <th>Temperature (°C)</th> </tr> </thead> <tbody> <tr> <td>1</td> <td>Reference temp. ± 2</td> </tr> <tr> <td>2</td> <td>Min. operating temp. ± 2</td> </tr> <tr> <td>3</td> <td>Reference temp. ± 2</td> </tr> <tr> <td>4</td> <td>Max. operating temp. ± 2</td> </tr> </tbody> </table>	Step	Temperature (°C)	1	Reference temp. ± 2	2	Min. operating temp. ± 2	3	Reference temp. ± 2	4	Max. operating temp. ± 2
Step	Temperature (°C)												
1	Reference temp. ± 2												
2	Min. operating temp. ± 2												
3	Reference temp. ± 2												
4	Max. operating temp. ± 2												
		X7S: ± 22%											
7	Robustness of Terminations	No sign of termination coming off, breakage of ceramic, or other abnormal signs.	Reflow solder the capacitor on P.C. board (shown in Appendix 1 and 2) and apply a pushing force of 2N for 10 ± 1s. <div style="text-align: center;"> <p>Capacitor P.C. Board</p> </div>										
8	Solderability	All terminations shall exhibit a continuous solder coating free from defects for a minimum of 75% of the surface area of any individual termination. Anomalies other than dewetting, non-wetting, and pin holes are not cause for rejection. Ceramic surface of A sections shall not be exposed due to melting or shifting of termination material.	Completely soak both terminations in solder at 235±5°C for 2±0.5s. Solder : H63A (JIS Z 3282) Flux : Isopropyl alcohol (JIS K 8839) Rosin (JIS K 5902) 25% solid solution.										

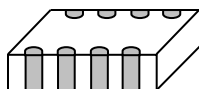

■ A section



General Specifications

CLL Series – ULI Capacitors

No.	Item	Performance	Test or Inspection Method	
9	Resistance to solder heat		Completely soak both terminations in solder at $260 \pm 5^\circ\text{C}$ for $5 \pm 1\text{s}$. Preheating condition Temp. : $150 \pm 10^\circ\text{C}$ Time : 1 to 2min. Flux : Isopropyl alcohol (JIS K 8839) Rosin (JIS K 5902) 25% solid solution. Solder : H63A (JIS Z 3282) Leave the capacitor in ambient conditions for $24 \pm 2\text{h}$ before measurement.	
	External appearance	No cracks are allowed and terminations shall be covered at least 60% with new solder		
	Capacitance	Characteristics		Change from the value before test
		X7R X7S		$\pm 7.5\%$
	D.F. (Class 2)	Meet the initial spec.		
Insulation Resistance	Meet the initial spec.			
10	Vibration		Reflow solder the capacitor on a P.C. board (shown in Appendix 1 and 2) before testing. Vibrate the capacitor with amplitude of 1.5mm P-P sweeping the frequencies from 10Hz to 55Hz and back to 10Hz in about 1 minute. Repeat this for 2h each in 3 perpendicular directions (6h in total).	
	External appearance	No mechanical damage.		
	Capacitance	Characteristics		Change from the value before test
		X7R X7S		$\pm 7.5\%$
	D.F. (Class 2)	Meet the initial spec.		
11	Temperature cycle		Reflow solder the capacitors on a P.C. board (shown in Appendix 1 and 2) before testing. Expose the capacitor in the condition step1 through step 4, and repeat 5 times consecutively. Leave the capacitor in ambient conditions for $24 \pm 2\text{h}$ before measurement.	
	External appearance	No mechanical damage.		
	Capacitance	Characteristics		Change from the value before test
		X7R X7S		$\pm 7.5\%$
	D.F. (Class 2)	Meet the initial spec.		
Insulation Resistance	Meet the initial spec.			
Voltage Proof	No insulation breakdown or other damage.			

Step	Temperature (°C)	Time (min.)
1	Min. operating temp. ± 3	30 ± 3
2	Reference Temp.	2 - 5
3	Max. operating temp. ± 2	30 ± 2
4	Reference Temp.	2 - 5



General Specifications

CLL Series – ULI Capacitors

No.	Item	Performance	Test or Inspection Method	
12	Moisture Resistance (Steady State)		Reflow solder the capacitor on P.C. board (shown in Appendix 1 and 2) before testing. Leave at temperature $40 \pm 2^\circ\text{C}$ and 90 to 95%RH for 500 +24,0h. Leave the capacitor in ambient condition for $24 \pm 2\text{h}$ before measurement.	
	External appearance	No mechanical damage.		
	Capacitance	Characteristics		Change from the value before test
		X7R X7S		$\pm 12.5 \%$
D.F. (Class 2)	Characteristics: X7R: 200% of initial spec. max. X7S: 200% of initial spec. max.			
	Insulation Resistance	$10\text{M}\Omega \cdot \mu\text{F}$ min.		
13	Moisture Resistance		Reflow solder the capacitors on P.C. board (shown in Appendix 1 and 2) before testing. Apply the rated voltage at temperature $40 \pm 2^\circ\text{C}$ and 90 to 95%RH for 500 +24,0h. Charge/discharge current shall not exceed 50mA. Leave the capacitor in ambient conditions for $48 \pm 4\text{h}$ before measurement. Voltage conditioning: Voltage treat the capacitors under testing temperature and voltage for 1 hour. Leave the capacitors in ambient condition for $24 \pm 2\text{h}$ before measurement. Use this measurement for initial value.	
	External appearance	No mechanical damage.		
	Capacitance	Characteristics		Change from the value before test
		X7R X7S		$\pm 12.5 \%$
D.F. (Class 2)	Characteristics X7R: 200% of initial spec. max. X7S: 200% of initial spec. max.			
	Insulation Resistance	$5\text{M}\Omega \cdot \mu\text{F}$ min.		
14	Life		Reflow solder the capacitor on P.C. board (shown in Appendix 1 and 2) before testing. Apply 1 x rated voltage at $125 \pm 2^\circ\text{C}$ for 1,000 +48, 0h. Charge/discharge current shall not exceed 50mA. Leave the capacitors in ambient condition for $24 \pm 2\text{h}$ before measurement. Voltage conditioning: Voltage treat the capacitor under testing temperature and voltage for 1 hour. Leave the capacitor in ambient conditions for $48 \pm 4\text{h}$ before measurement. Use this measurement for initial value.	
	External appearance	No mechanical damage.		
	Capacitance	Characteristics		Change from the value before test
		X7R X7S		$\pm 15 \%$
D.F. (Class 2)	Characteristics X7R: 200% of initial spec. max. X7S: 200% of initial spec. max.			
	Insulation Resistance	$10\text{M}\Omega \cdot \mu\text{F}$ min.		



Appendix - 1

P.C. Board for reliability test
Applied for CLLC1A

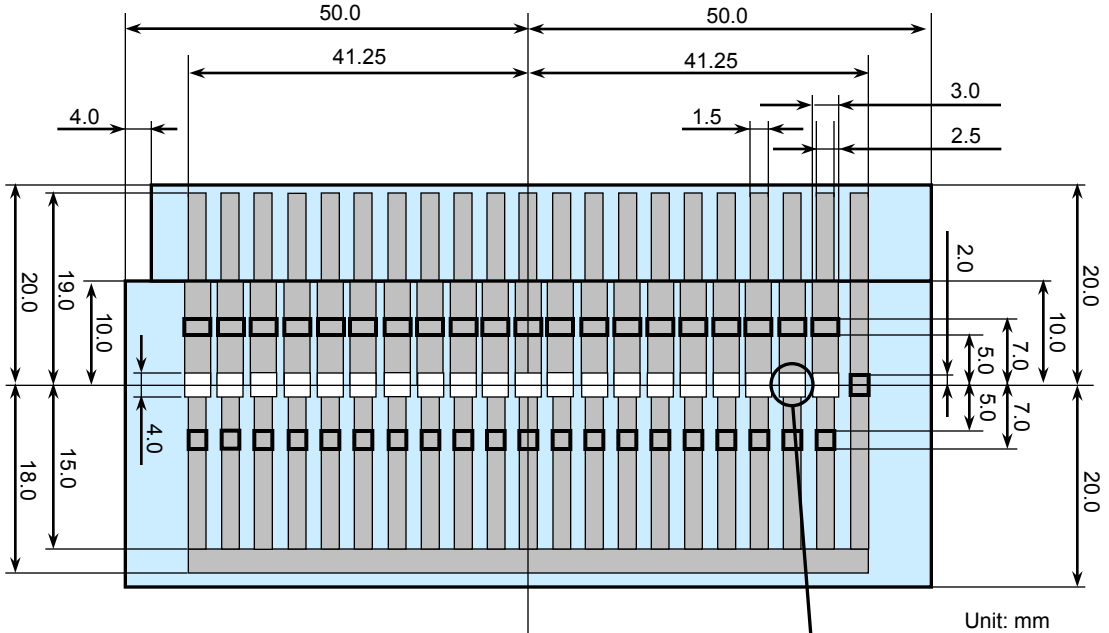

Unit: mm

Material: Glass Epoxy (As per JIS C6484 GE4)

P.C. Board thickness: 0.8mm

- Copper (thickness 0.035mm)
- Solder resist

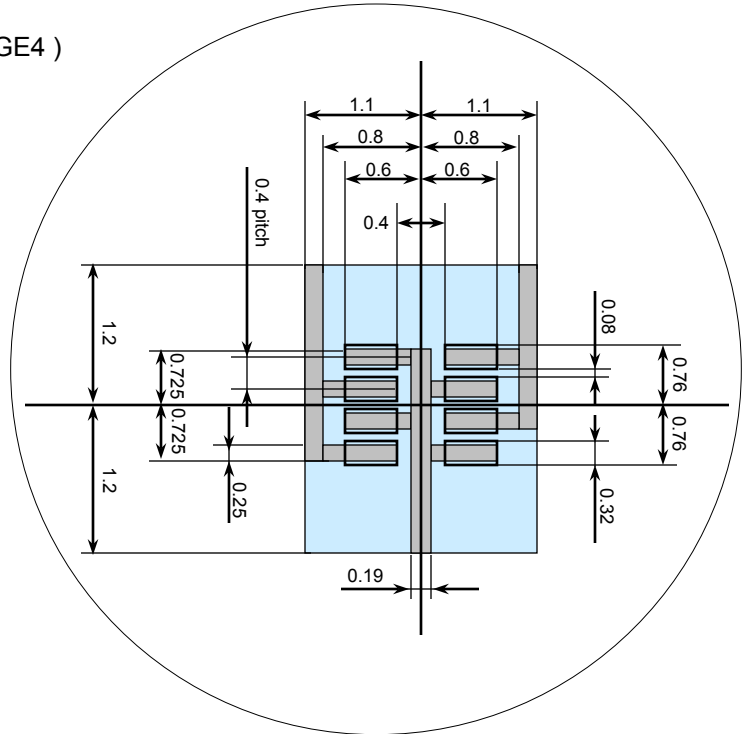



Appendix - 2

P.C. Board for reliability test

Applied for CLLE1A

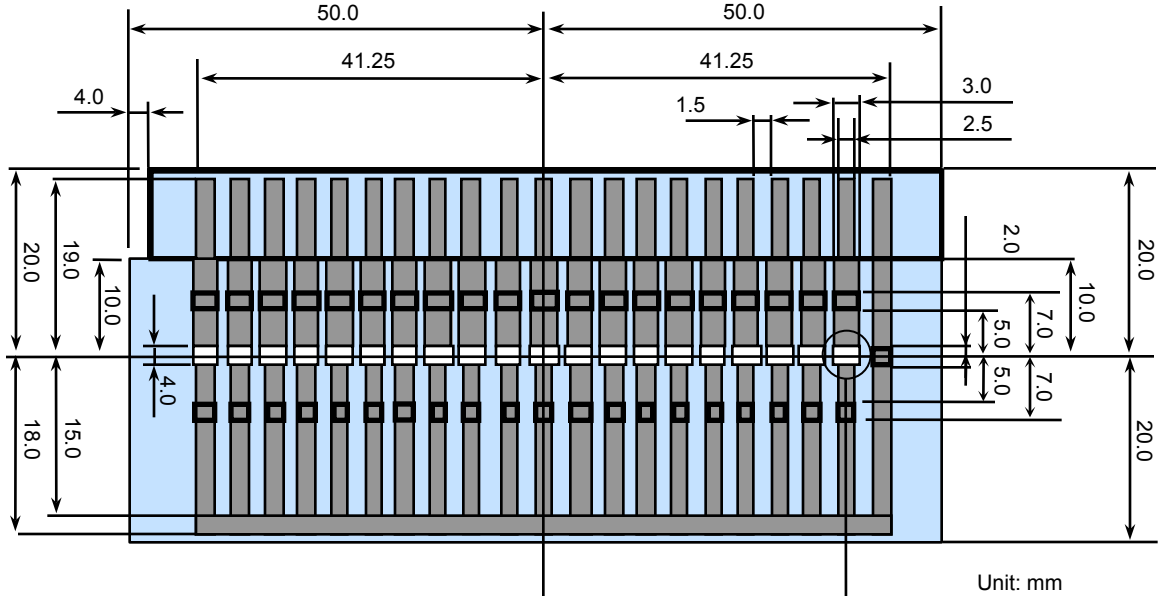

Unit: mm

Material: Glass Epoxy (As per JIS C6484 GE4)

P.C. Board thickness: 1.6mm

- Copper (thickness 0.035mm)
- Solder resist

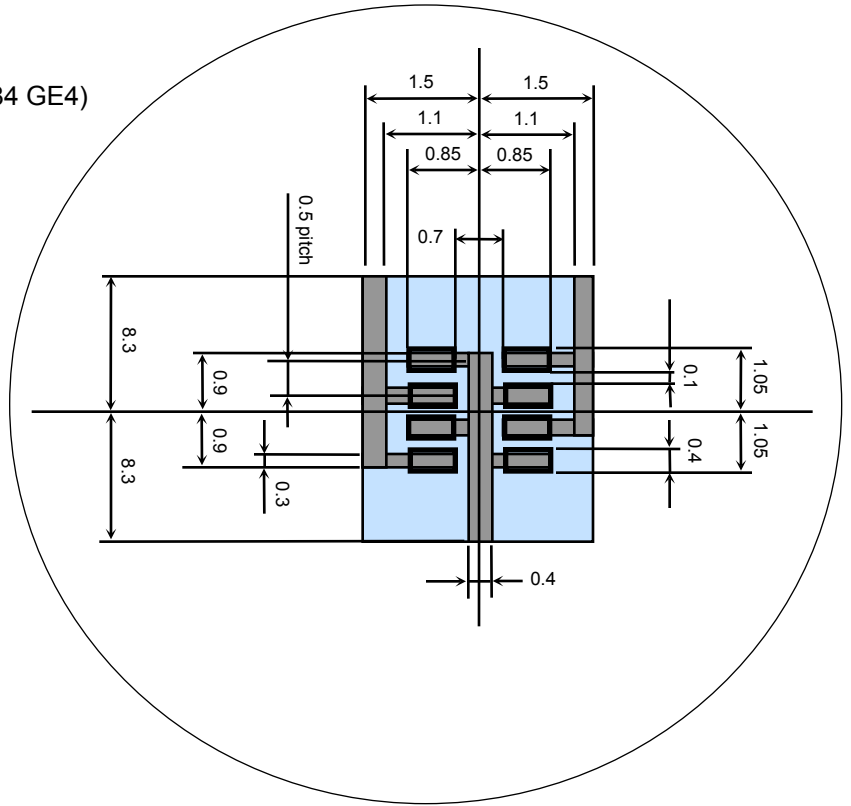

Soldering Information

CLL Series – ULI Capacitors

Recommended Soldering Land Pattern

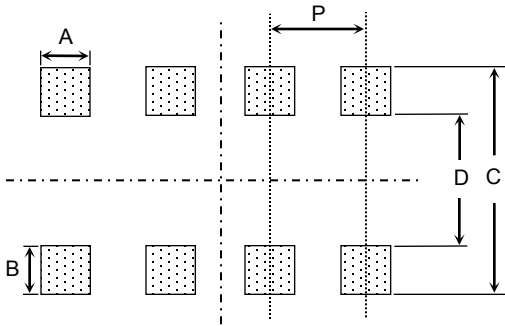

Recommended Soldering Profile

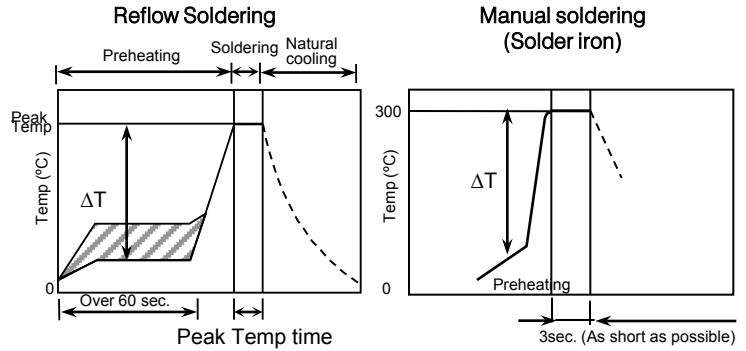

Reflow Soldering

Unit: mm

Type	CLLC1A (C1608/CC0603)	CLLE1A (C2012/CC0805)
A	0.25	0.3
B	0.4	0.3 ~ 0.6
C	1.2	1.3 ~ 1.8
D	0.4	0.5 ~ 0.8
P	0.4	0.5

Recommended Solder Amount

Excessive solder

Higher tensile force on the chip capacitor may cause cracking.

Adequate solder

Insufficient solder

Small solder fillet may cause contact failure or failure to hold the chip capacitor to the P.C. board.

Recommended soldering duration

Solder	Temp./Dura.	Reflow Soldering	
		Peak temp (°C)	Duration (sec.)
Sn-Pb Solder		230 max.	20 max.
Lead-Free Solder		260 max.	10 max.

Recommended solder compositions

Sn-37Pb (Sn-Pb solder)

Sn-3.0Ag-0.5Cu (Lead Free Solder)

Preheating Condition

Soldering	Temp. (°C)
Reflow soldering	$\Delta T \leq 150$
Manual soldering	$\Delta T \leq 150$



Packaging Information

CLL Series – ULI Capacitors

Carrier Tape Configuration

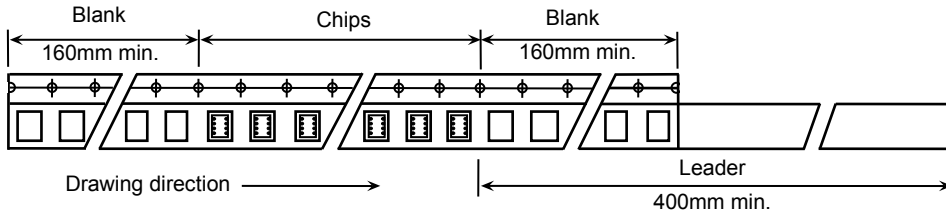

Peel Back Force (Top Tape)

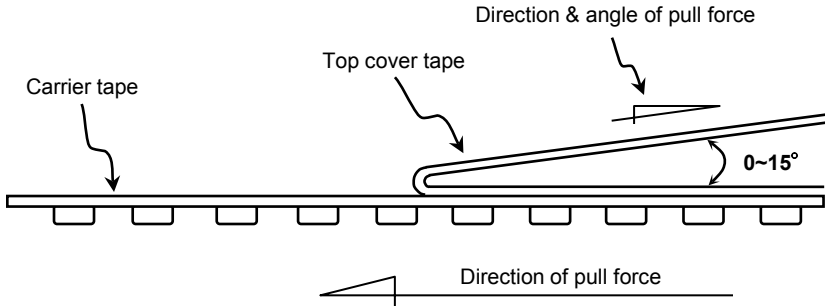

- Carrier tape shall be flexible enough to be wound around a minimum radius of 30mm with components in tape.
- The missing of components shall be less than 0.1%
- Components shall not stick to the cover tape.
- The cover tape shall not protrude beyond the edges of the carrier tape and shall not cover the sprocket holes.

Chip Quantity Per Reel and Structure of Reel

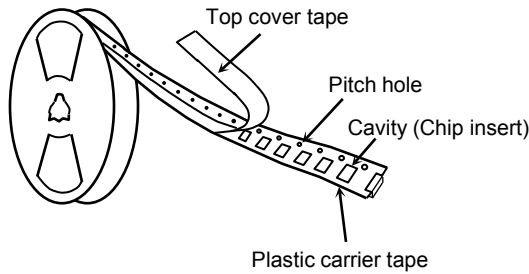

Series	Taping Material	Chip quantity (pcs.)	
		φ178mm (7") reel	φ330mm (13") reel
CLLC1A	Plastic	4,000	10,000
CLLE1A		4,000	10,000



Additional Information

CLL Series – ULI Capacitors

• Inside Structure & Material System

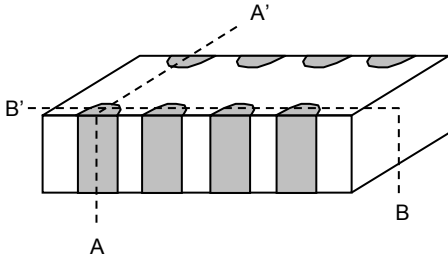

No.	NAME	MATERIAL
		Class 2
(1)	Ceramic Dielectric	BaTiO ₃
(2)	Internal Electrode	Nickel (Ni)
(3)	Termination	Copper (Cu)
(4)		Nickel (Ni)
(5)		Tin (Sn)

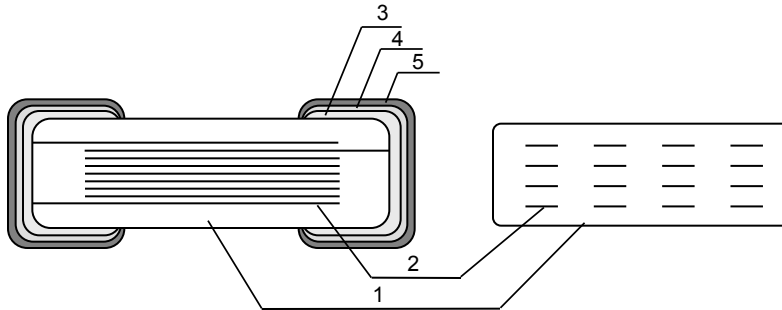

• Equivalent Circuit

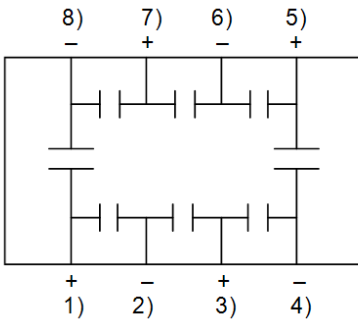

+ 1) 3) 5) 7)
- 2) 4) 6) 8)

8 terminals are connected and measured at the same time.

• Shape & Dimensions

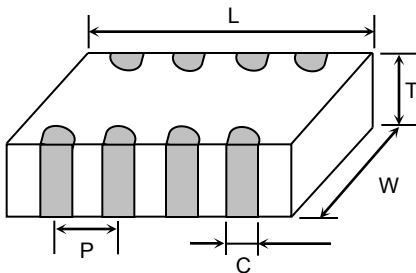

• Environmental Information

TDK Corporation established internal product environmental assurance standards that include the six hazardous substances banned by the EU RoHS Directive¹ enforced on July 1, 2006 along with additional substances independently banned by TDK and has successfully completed making general purpose electronic components conform to the RoHS Directive².

1. Abbreviation for Restriction on Hazardous Substances, which refers to the regulation EU Directive 2002/95/EC on hazardous substances by the European Union (EU) effective from July 1, 2006. The Directive bans the use of six specific hazardous substances in electric and electronic devices and products handled within the EU. The six substances are lead, mercury, cadmium, hexavalent chromium, PBB (polybrominated biphenyls), and PBDE (polybrominated diphenyl ethers).
2. This means that, in conformity with the EU Directive 2002/95/EC, lead, cadmium, mercury, hexavalent chromium, and specific bromine-based flame retardants, PBB and PBDE, have not been used, except for exempted applications.

For REACH (SVHC : 15 substances according to ECHA / October 2008) : All TDK MLCC do not contain these 15 substances.

For European Directive 2000/53/CE and 2005/673/CE : Cadmium, Hexavalent Chromium, Mercury, Lead are not contained in all TDK MLCC.

For European Directive 2003/11/CE : Pentabromodiphenyl-ether, Octabromodiphenyl-ether are not contained in all TDK MLCC.

Case Code			Dimensions (mm)				
Series	JIS	EIA	L	W	T	P	C
CLLC1A	C1608	CC0603	1.60	0.80	0.55 max.	0.40	0.25
CLLE1A	C2012	CC0805	2.00	1.25	0.95 max.	0.50	0.25